



SOT23, Very High Precision, 3V/5V Rail-to-Rail Op Amps

General Description

The MAX4236/MAX4237 are high-precision op amps that feature an exceptionally low offset voltage and offset voltage temperature coefficient without using any chopper techniques. The MAX4236 and MAX4237 have a typical large-signal, open-loop voltage gain of 120dB. These devices have an ultra-low input-bias current of 1pA. The MAX4236 is unity-gain stable with a gain-bandwidth product of 1.7MHz, while the MAX4237 is stable for closed-loop gains greater than 5V/V with a gain-bandwidth product of 7.5MHz. Both devices have a shutdown function in which the quiescent current is reduced to less than 0.1 μ A, and the amplifier output is forced into a high-impedance state.

The input common-mode range of the MAX4236/MAX4237 extends below the negative supply range, and the output swings Rail-to-Rail[®]. These features make the amplifiers ideal for applications with +3V or +5V single power supplies. The MAX4236/MAX4237 are specified for the extended temperature range (-40°C to +85°C) and are available in tiny SOT23, μ MAX, and SO packages. For greater accuracy, the A grade μ MAX and SO packages are tested to guarantee 20 μ V (max) offset voltage at +25°C and less than 2 μ V/°C drift.

Applications

Strain Gauges
Piezoelectric Sensors
Thermocouple Amplifiers
Electrochemical Sensors
Battery-Powered Instrumentation
Instrumentation Amplifiers

Rail-to-Rail is a registered trademark of Nippon Motorola, Inc.

Pin Configurations

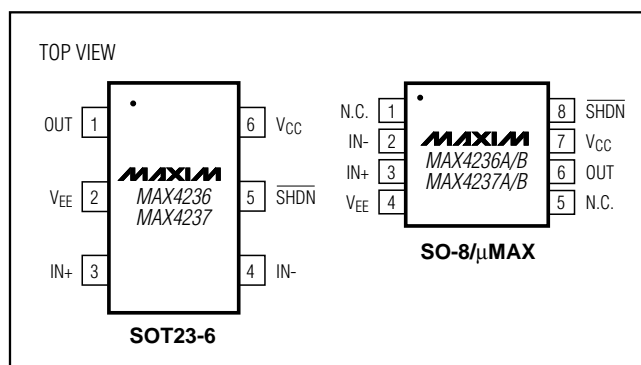

Features

- ◆ Ultra-Low Offset Voltage
 - 20 μ V (max) at +25°C (Grade A)
 - 50 μ V (max) at +25°C (Grade B, 6-Pin SOT23)
- ◆ Ultra-Low Offset Voltage Drift
 - 2 μ V/°C (max) (Grade A)
 - 4.5 μ V/°C (max) (Grade B, 6-Pin SOT23)
 - 5.5 μ V/°C (max) (6-Pin SOT23)
- ◆ Ultra-Low 1pA Input Bias Current
- ◆ High Open-Loop Voltage Gain: 110dB (min) (R_L = 100k Ω)
- ◆ Compatible with +3V and +5V Single-Supply Power Systems
- ◆ Ground Sensing: Input Common-Mode Range Includes Negative Rail
- ◆ Rail-to-Rail Output Swing into a 1k Ω Load
- ◆ 350 μ A Quiescent Current
- ◆ Gain-Bandwidth Product
 - 1.7MHz (MAX4236, A_V = 1V/V)
 - 7.5MHz (MAX4237, A_V = 5V/V)
- ◆ 200pF Capacitive Load Handling Capability
- ◆ Shutdown Mode: 0.1 μ A Quiescent Current, Places Output in a High-Impedance State
- ◆ Available in Space-Saving SOT23 and μ MAX Packages

MAX4236/MAX4237

Ordering Information

PART	TEMP. RANGE	PIN-PACKAGE
MAX4236EUT-T	-40°C to +85°C	6 SOT23-6
MAX4236AEUA	-40°C to +85°C	8 μ MAX
MAX4236BEUA	-40°C to +85°C	8 μ MAX
MAX4236AESA	-40°C to +85°C	8 SO
MAX4236BESA	-40°C to +85°C	8 SO
MAX4237EUT-T	-40°C to +85°C	6 SOT23-6
MAX4237AEUA	-40°C to +85°C	8 μ MAX
MAX4237BEUA	-40°C to +85°C	8 μ MAX
MAX4237AESA	-40°C to +85°C	8 SO
MAX4237BESA	-40°C to +85°C	8 SO



SOT23, Very High Precision, 3V/5V Rail-To-Rail Op Amps

ABSOLUTE MAXIMUM RATINGS

Supply Voltage ($V_{CC} - V_{EE}$)-0.3V to +6V
 Analog Input Voltage (IN+ or IN-)....($V_{EE} - 0.3V$) to ($V_{CC} + 0.3V$)
 Logic Input Voltage (SHDN)($V_{EE} - 0.3V$) to ($V_{CC} + 0.3V$)
 Current into Any Pin20mA
 Output Short-Circuit Duration....Continuous to Either V_{CC} or V_{EE}
 Continuous Power Dissipation ($T_A = +70^\circ\text{C}$)
 6-Pin SOT23-6 (derate 8.7mW/ $^\circ\text{C}$ above $+70^\circ\text{C}$)696mW
 8-Pin μMAX (derate 4.5mW/ $^\circ\text{C}$ above $+70^\circ\text{C}$)362mW
 8-Pin SO (derate 5.9mW/ $^\circ\text{C}$ above $+70^\circ\text{C}$)471mW

Operating Temperature Range-40 $^\circ\text{C}$ to +85 $^\circ\text{C}$
 Junction Temperature+150 $^\circ\text{C}$
 Storage Temperature Range-65 $^\circ\text{C}$ to +150 $^\circ\text{C}$
 Lead Temperature (soldering, 10s)+300 $^\circ\text{C}$

Stresses beyond those listed under "Absolute Maximum Ratings" may cause permanent damage to the device. These are stress ratings only, and functional operation of the device at these or any other conditions beyond those indicated in the operational sections of the specifications is not implied. Exposure to absolute maximum rating conditions for extended periods may affect device reliability.

ELECTRICAL CHARACTERISTICS (SO-8 and μMAX -8)

($V_{CC} = +2.4V$ to $+5.5V$, $V_{EE} = 0$, $V_{CM} = 0$, $V_{OUT} = V_{CC}/2$, $R_L = 100k\Omega$ to $V_{CC}/2$, $T_A = T_{MIN}$ to T_{MAX} , unless otherwise noted. Typical values are at $V_{CC} = +5V$ and $T_A = +25^\circ\text{C}$.) (Note 1)

PARAMETER	SYMBOL	CONDITIONS		MIN	TYP	MAX	UNITS
Supply Voltage Range	V_{CC}	Guaranteed by the PSRR test		2.4		5.5	V
Quiescent Supply Current	I_{CC}	$V_{CC} = +5V$	In normal mode		350	440	μA
			In shutdown mode		0.1	2	
		$V_{CC} = +3V$	In normal mode		350	440	
			In shutdown mode		0.1	2	
Input Offset Voltage	V_{OS}	$V_{CC} = +5V$, Grade A	$T_A = +25^\circ\text{C}$		± 5	± 20	μV
			$T_A = T_{MIN}$ to T_{MAX}			± 150	
		$V_{CC} = +5V$, Grade B	$T_A = +25^\circ\text{C}$		± 5	± 50	
			$T_A = T_{MIN}$ to T_{MAX}			± 340	
Input Offset Voltage Temperature Coefficient	TCV_{OS}	$V_{CC} = +5V$ (Note 3)	Grade A		± 0.6	± 2	$\mu\text{V}/^\circ\text{C}$
			Grade B		± 0.6	± 4.5	
Input Bias Current	I_B	(Note 2)			± 1	± 500	pA
Input Offset Current	I_{OS}	(Note 2)			± 1		pA
Input Resistance	R_{IN}	Differential or common mode			1000		$M\Omega$
Input Common-Mode Voltage	V_{CM}	Guaranteed by the CMRR test		-0.15		$V_{CC} - 1.2$	V
Common-Mode Rejection Ratio	CMRR	$V_{CC} = +5V$; $-0.15V \leq V_{CM} \leq$ ($V_{CC} - 1.2V$)	$T_A = +25^\circ\text{C}$		84	102	dB
			$T_A = T_{MIN}$ to T_{MAX}		80		
		$V_{CC} = +3.0V$; $-0.15V \leq V_{CM} \leq$ ($V_{CC} - 1.2V$)	$T_A = +25^\circ\text{C}$		82	102	
			$T_A = T_{MIN}$ to T_{MAX}		78		
Power-Supply Rejection Ratio	PSRR	$V_{CC} = +2.4V$ to $+5.5V$	$T_A = +25^\circ\text{C}$		97	120	dB
			$T_A = T_{MIN}$ to T_{MAX}		95		

SOT23, Very High Precision, 3V/5V Rail-To-Rail Op Amps

MAX4236/MAX4237

ELECTRICAL CHARACTERISTICS (SO-8 and μ MAX-8) (continued)

($V_{CC} = +2.4V$ to $+5.5V$, $V_{EE} = 0$, $V_{CM} = 0$, $V_{OUT} = V_{CC}/2$, $R_L = 100k\Omega$ to $V_{CC}/2$, $T_A = T_{MIN}$ to T_{MAX} , unless otherwise noted. Typical values are at $V_{CC} = +5V$ and $T_A = +25^\circ C$.) (Note 1)

PARAMETER	SYMBOL	CONDITIONS		MIN	TYP	MAX	UNITS
Large-Signal Voltage Gain	A_{VOL}	$V_{CC} = +5V$, R_L connected to $V_{CC}/2$, $T_A = +25^\circ C$	$R_L = 100k\Omega$, $V_{OUT} = 15mV$ to $(V_{CC} - 50mV)$	110	128		dB
			$R_L = 1k\Omega$, $V_{OUT} = 0.15V$ to $(V_{CC} - 0.3V)$	105	114		
		$V_{CC} = +5V$, R_L connected to $V_{CC}/2$, $T_A = T_{MIN}$ to T_{MAX}	$R_L = 100k\Omega$, $V_{OUT} = 15mV$ to $(V_{CC} - 50mV)$	110			
			$R_L = 1k\Omega$, $V_{OUT} = 0.15V$ to $(V_{CC} - 0.3V)$	100			
		$V_{CC} = +3V$, R_L connected to $V_{CC}/2$, $T_A = +25^\circ C$	$R_L = 100k\Omega$, $V_{OUT} = 15mV$ to $(V_{CC} - 50mV)$	110	128		
			$R_L = 1k\Omega$, $V_{OUT} = 0.15V$ to $(V_{CC} - 0.3V)$	100	114		
		$V_{CC} = +3V$, R_L connected to $V_{CC}/2$, $T_A = T_{MIN}$ to T_{MAX}	$R_L = 100k\Omega$, $V_{OUT} = 15mV$ to $(V_{CC} - 50mV)$	105			
			$R_L = 1k\Omega$, $V_{OUT} = 0.15V$ to $(V_{CC} - 0.3V)$	95			
Output Voltage Swing	V_{OUT}	$V_{CC} = +5V$, R_L connected to $V_{CC}/2$, $R_L = 100k\Omega$	$V_{CC} - V_{OH}$		2	10	mV
			$V_{OL} - V_{EE}$		3	10	
		$V_{CC} = +5V$, R_L connected to $V_{CC}/2$, $R_L = 1k\Omega$	$V_{CC} - V_{OH}$		150	250	
			$V_{OL} - V_{EE}$		50	100	
Output Short-Circuit Current	$I_{OUT(SC)}$	Shorted to V_{EE}			10		mA
		Shorted to V_{CC}			30		
Gain-Bandwidth Product	GBWP	$R_L = \infty$, $C_L = 5pF$	MAX4236		1.7		MHz
			MAX4237		7.5		
Slew Rate	SR	$V_{CC} = +5V$, $V_{OUT} = 4V$ step	MAX4236		0.3		V/ μs
			MAX4237		1.3		
Settling Time	t_s	V_{OUT} settling to within 0.01%	MAX4236		1		μs
			MAX4237		1		
Total Harmonic Distortion	THD	$f = 5kHz$, $V_{OUT} = 2V_{p-p}$, $V_{CC} = +5V$, $R_L = 10k\Omega$			0.001		%

SOT23, Very High Precision, 3V/5V Rail-To-Rail Op Amps

ELECTRICAL CHARACTERISTICS (SO-8 and μ MAX-8) (continued)

($V_{CC} = +2.4V$ to $+5.5V$, $V_{EE} = 0$, $V_{CM} = 0$, $V_{OUT} = V_{CC}/2$, $R_L = 100k\Omega$ to $V_{CC}/2$, $T_A = T_{MIN}$ to T_{MAX} , unless otherwise noted. Typical values are at $V_{CC} = +5V$ and $T_A = +25^\circ C$.) (Note 1)

PARAMETER	SYMBOL	CONDITIONS		MIN	TYP	MAX	UNITS
Input Capacitance	C_{IN}	$f = 100kHz$			7.5		pF
Input Voltage Noise Density	e_n	$f = 1kHz$			14		nV/ \sqrt{Hz}
Input Noise Voltage	e_{np-p}	$f = 0.1Hz$ to $10Hz$			0.2		μV_{p-p}
Capacitive Load Stability	C_{LOAD}	No sustained oscillations	MAX4236		200		pF
			MAX4237		200		
Shutdown Mode Output Leakage	$I_{OUT(SH)}$	Device in shutdown mode ($\overline{SHDN} = V_{EE}$) $V_{OUT} = 0$ to V_{CC}			± 0.01	± 1.0	μA
\overline{SHDN} Logic Low	V_{IL}					$0.3 \times V_{CC}$	V
\overline{SHDN} Logic High	V_{IH}			$0.7 \times V_{CC}$			V
\overline{SHDN} Input Current		$\overline{SHDN} = V_{EE}$ or V_{CC}			1	3	μA
Shutdown Delay Time	$t_{(SH)}$	$R_L = 1k\Omega$			1		μs
Shutdown Recovery Time	$t_{(EN)}$	$R_L = 1k\Omega$			4		μs

ELECTRICAL CHARACTERISTICS (SOT23-6)

($V_{CC} = +2.4V$ to $+5.5V$, $V_{EE} = 0$, $V_{CM} = 0$, $V_{OUT} = V_{CC}/2$, $R_L = 100k\Omega$ to $V_{CC}/2$, $T_A = T_{MIN}$ to T_{MAX} , unless otherwise noted. Typical values are at $V_{CC} = +5V$ and $T_A = +25^\circ C$.) (Note 1)

PARAMETER	SYMBOL	CONDITIONS		MIN	TYP	MAX	UNITS
Supply Voltage Range	V_{CC}	Guaranteed by the PSRR test		2.4		5.5	V
Quiescent Supply Current	I_{CC}	$V_{CC} = +5V$	In normal mode		350	440	μA
			In shutdown mode		0.1	2	
		$V_{CC} = +3V$	In normal mode		350	440	
			In shutdown mode		0.1	2	
Input Offset Voltage	V_{OS}	$V_{CC} = +5V$	$T_A = +25^\circ C$		± 5	± 50	μV
			$T_A = T_{MIN}$ to T_{MAX}			± 600	
Input Offset Voltage Temperature Coefficient (Note 2)	TCV_{OS}	$V_{CC} = +5V$			± 0.6	± 5.5	$\mu V/^\circ C$
Input Bias Current	I_B	(Note 2)			± 1	± 500	pA
Input Offset Current	I_{OS}	(Note 2)			± 1		pA
Input Resistance	R_{IN}	Differential or common mode			1000		$M\Omega$
Input Common-Mode Voltage	V_{CM}	Guaranteed by the CMRR test		-0.15		$V_{CC} - 1.2$	V
Common-Mode Rejection Ratio	CMRR	$V_{CC} = +5V$, $-0.15V \leq V_{CM} \leq (V_{CC} - 1.2V)$	$T_A = +25^\circ C$		82	102	dB
			$T_A = T_{MIN}$ to T_{MAX}		80		
		$V_{CC} = +3.0V$; $-0.15V \leq V_{CM} \leq (V_{CC} - 1.2V)$	$T_A = +25^\circ C$		82	102	
			$T_A = T_{MIN}$ to T_{MAX}		78		

SOT23, Very High Precision, 3V/5V Rail-To-Rail Op Amps

MAX4236/MAX4237

ELECTRICAL CHARACTERISTICS (SOT23-6) (continued)

($V_{CC} = +2.4V$ to $+5.5V$, $V_{EE} = 0$, $V_{CM} = 0$, $V_{OUT} = V_{CC}/2$, $R_L = 100k\Omega$ to $V_{CC}/2$, $T_A = T_{MIN}$ to T_{MAX} , unless otherwise noted. Typical values are at $V_{CC} = +5V$ and $T_A = +25^\circ C$.) (Note 1)

PARAMETER	SYMBOL	CONDITIONS		MIN	TYP	MAX	UNITS			
Power-Supply Rejection Ratio	PSRR	$V_{CC} = +2.4V$ to $+5.5V$	$T_A = +25^\circ C$	97	120		dB			
			$T_A = T_{MIN}$ to T_{MAX}	95						
Large-Signal Voltage Gain	AVOL	$V_{CC} = +5V$, R_L connected to $V_{CC}/2$, $T_A = +25^\circ C$	$R_L = 100k\Omega$, $V_{OUT} = 15mV$ to $(V_{CC} - 50mV)$	110	128		dB			
			$R_L = 1k\Omega$, $V_{OUT} = 0.15V$ to $(V_{CC} - 0.3V)$	100	114					
		$V_{CC} = +5V$, R_L connected to $V_{CC}/2$, $T_A = T_{MIN}$ to T_{MAX}	$R_L = 100k\Omega$, $V_{OUT} = 15mV$ to $(V_{CC} - 50mV)$	110						
			$R_L = 1k\Omega$, $V_{OUT} = 0.15V$ to $(V_{CC} - 0.3V)$	95						
		$V_{CC} = +3V$, R_L connected to $V_{CC}/2$, $T_A = +25^\circ C$	$R_L = 100k\Omega$, $V_{OUT} = 15mV$ to $(V_{CC} - 50mV)$	110	128					
			$R_L = 1k\Omega$, $V_{OUT} = 0.15V$ to $(V_{CC} - 0.3V)$	100	114					
		$V_{CC} = +3V$, R_L connected to $V_{CC}/2$, $T_A = T_{MIN}$ to T_{MAX}	$R_L = 100k\Omega$, $V_{OUT} = 15mV$ to $(V_{CC} - 50mV)$	105						
			$R_L = 1k\Omega$, $V_{OUT} = 0.15V$ to $(V_{CC} - 0.3V)$	95						
		Output Voltage Swing	V _{OUT}	$V_{CC} = +5V$, R_L connected to $V_{CC}/2$, $R_L = 100k\Omega$	$V_{CC} - V_{OH}$			2	10	mV
					$V_{OL} - V_{EE}$			3	10	
$V_{CC} = +5V$, R_L connected to $V_{CC}/2$, $R_L = 1k\Omega$	$V_{CC} - V_{OH}$				150	250				
	$V_{OL} - V_{EE}$				50	100				
Output Short-Circuit Current	I _{OUT(SC)}	Shorted to V_{EE}			10		mA			
		Shorted to V_{CC}			30					
Gain-Bandwidth Product	GBWP	$R_L = \infty$, $C_L = 15pF$	MAX4236		1.7		MHz			
			MAX4237		7.5					
Slew Rate	SR	$V_{CC} = +5V$, $V_{OUT} = 4V$ step	MAX4236		0.3		V/ μs			
			MAX4237		1.3					

SOT23, Very High Precision, 3V/5V Rail-To-Rail Op Amps

ELECTRICAL CHARACTERISTICS (SOT23-6) (continued)

($V_{CC} = +2.4V$ to $+5.5V$, $V_{EE} = 0$, $V_{CM} = 0$, $V_{OUT} = V_{CC}/2$, $R_L = 100k\Omega$ to $V_{CC}/2$, $T_A = T_{MIN}$ to T_{MAX} , unless otherwise noted. Typical values are at $V_{CC} = +5V$ and $T_A = +25^\circ C$.) (Note 1)

PARAMETER	SYMBOL	CONDITIONS	MIN	TYP	MAX	UNITS
Settling Time	t_s	V_{OUT} settling to within 0.01%	MAX4236	1		μs
			MAX4237	1		
Total Harmonic Distortion	THD	$f = 5kHz$, $V_{OUT} = 2V_{p-p}$, $V_{CC} = +5V$ $R_L = 10k\Omega$	0.001			%
Input Capacitance	C_{IN}	$f = 100kHz$	7.5			pF
Input Voltage Noise Density	e_n	$f = 1kHz$	14			nV/ \sqrt{Hz}
Input Noise Voltage	e_{n-p-p}	$f = 0.1Hz$ to $10Hz$	0.2			μV_{p-p}
Capacitive Load Stability	C_{LOAD}	No sustained oscillations	MAX4236	200		pF
			MAX4237	200		
Shutdown Mode Output Leakage	$I_{OUT(SH)}$	Device in shutdown mode ($\overline{SHDN} = V_{EE}$) $V_{OUT} = 0$ to V_{CC}	± 0.01	± 1.0		μA
\overline{SHDN} Logic Low	V_{IL}		$0.3 \times V_{CC}$			V
\overline{SHDN} Logic High	V_{IH}		$0.7 \times V_{CC}$			V
\overline{SHDN} Input Current		$\overline{SHDN} = V_{EE}$ or V_{CC}		1	3	μA
Shutdown Delay Time	$t_{(SH)}$	$R_L = 1k\Omega$	1			μs
Shutdown Recovery Time	$t_{(EN)}$	$R_L = 1k\Omega$	4			μs

Note 1: All devices are 100% production tested at $T_A = +25^\circ C$; all specifications over temperature are guaranteed by design, unless otherwise specified.

Note 2: Guaranteed by design, not production tested.

Note 3: Maxim specification limits for the temperature coefficient of the offset voltage (TCV_{OS}) are 100% tested for the A-grade, 8-pin SO and μ MAX packages.

Typical Operating Characteristics

($V_{CC} = +5V$, $V_{EE} = 0$, $V_{CM} = V_{CC}/2$, $R_L = 100k\Omega$ to $V_{CC}/2$, $T_A = +25^\circ C$, unless otherwise noted.)

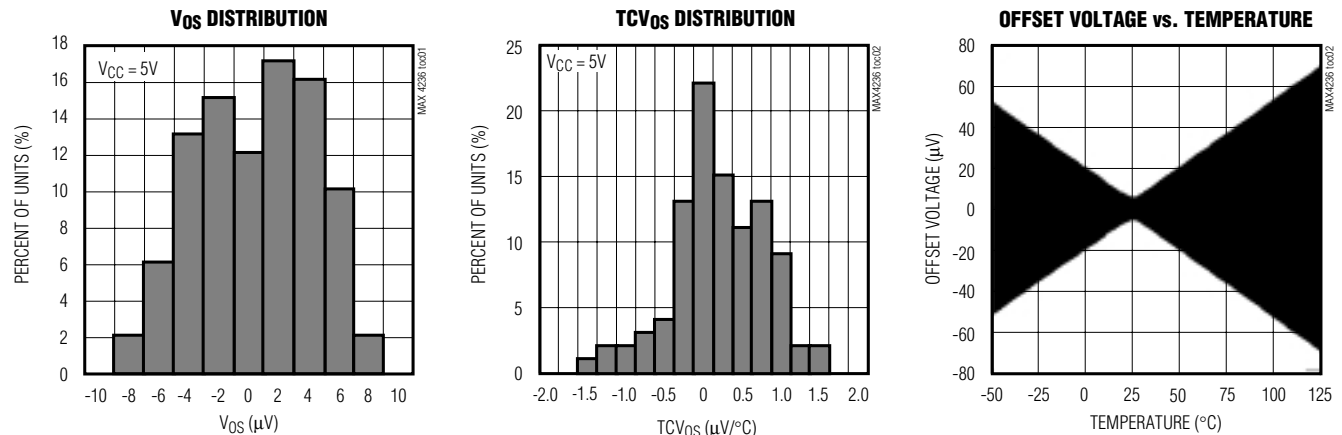

SOT23, Very High Precision, 3V/5V Rail-To-Rail Op Amps

MAX4236/MAX4237

Typical Operating Characteristics (continued)

($V_{CC} = +5V$, $V_{EE} = 0$, $V_{CM} = V_{CC}/2$, $R_L = 100k\Omega$ to $V_{CC}/2$, $T_A = +25^\circ C$, unless otherwise noted.)

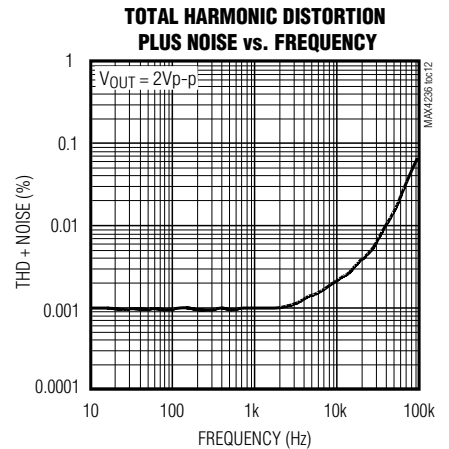
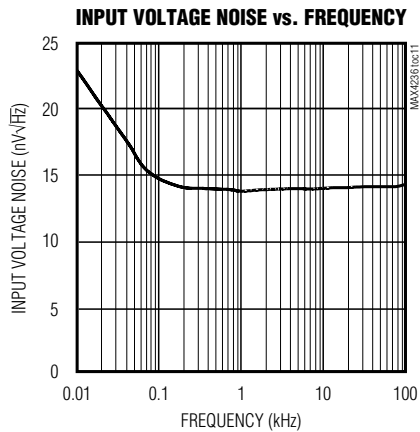
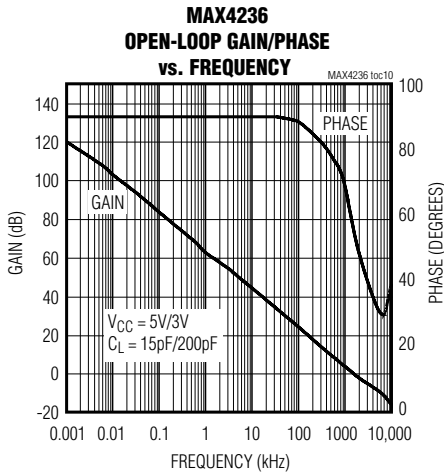
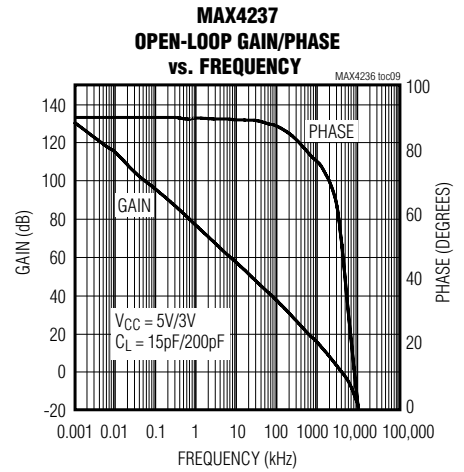
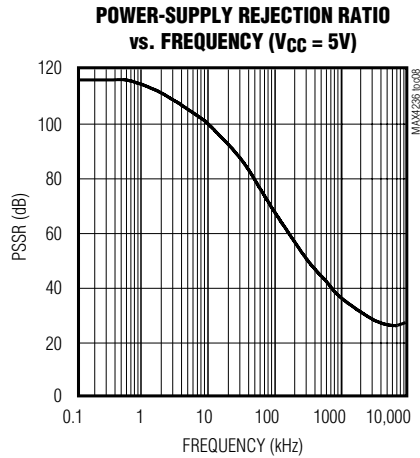
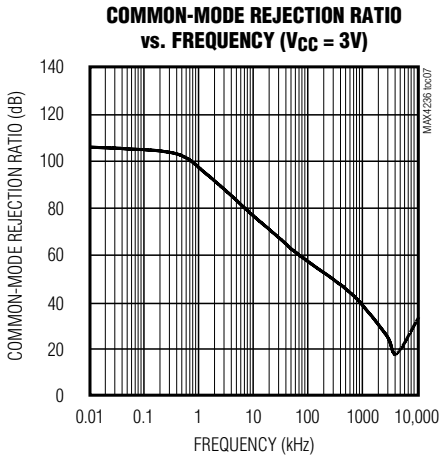
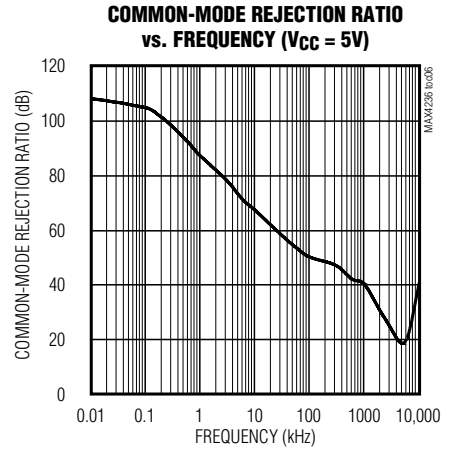
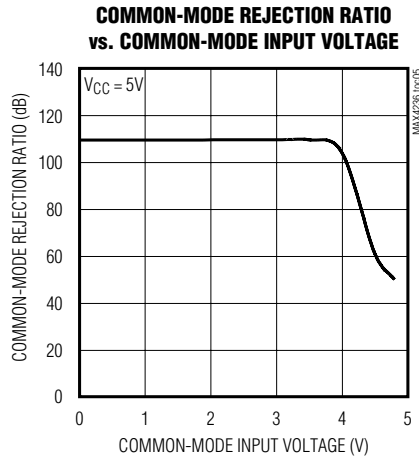
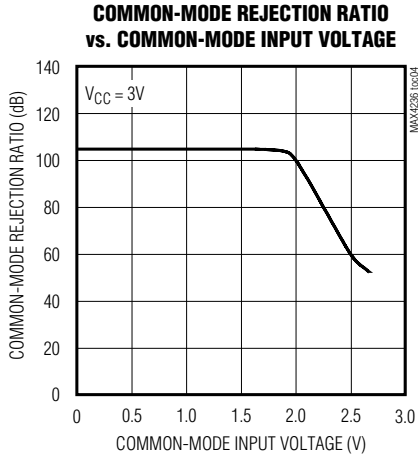

SOT23, Very High Precision, 3V/5V Rail-To-Rail Op Amps

Typical Operating Characteristics (continued)

($V_{CC} = +5V$, $V_{EE} = 0$, $V_{CM} = V_{CC}/2$, $R_L = 100k\Omega$ to $V_{CC}/2$, $T_A = +25^\circ C$, unless otherwise noted.)

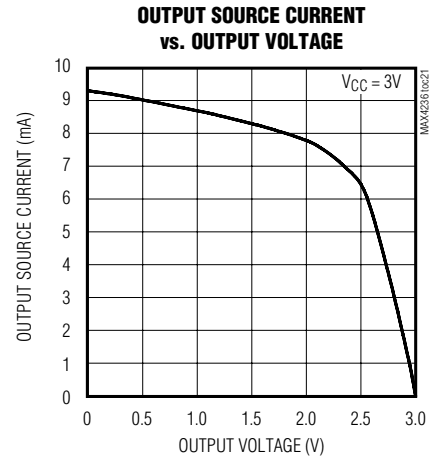
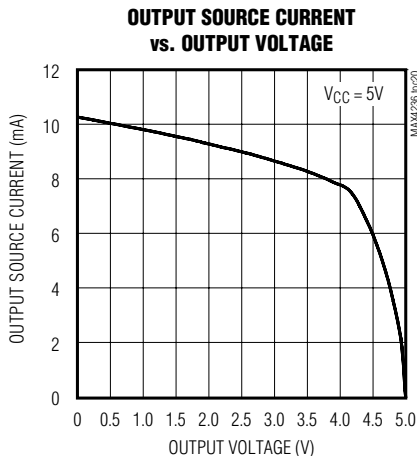
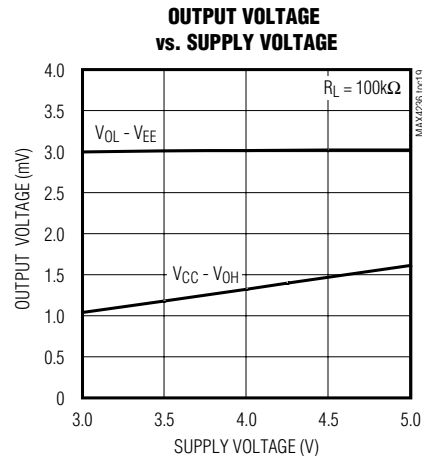
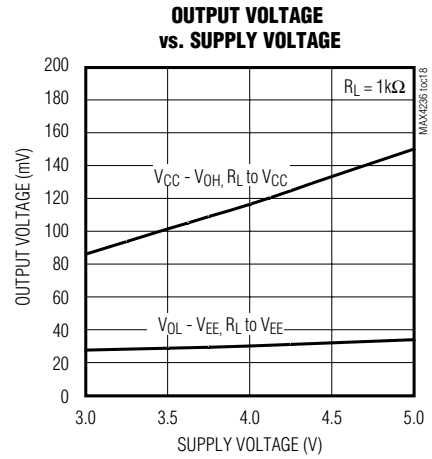
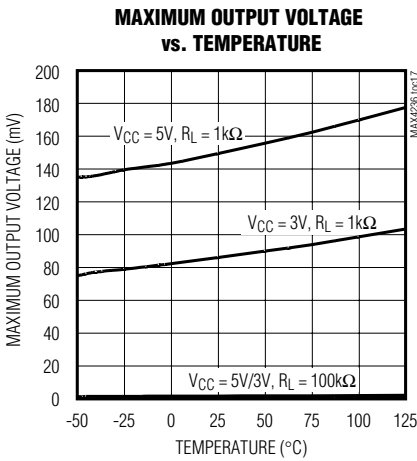
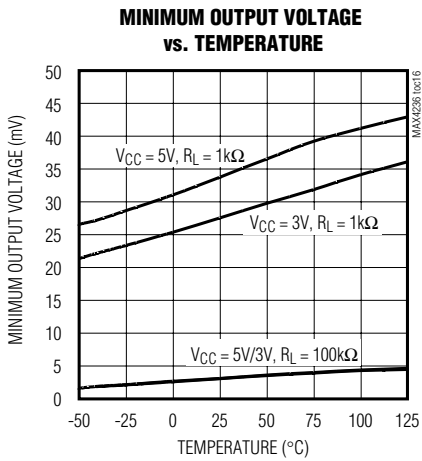
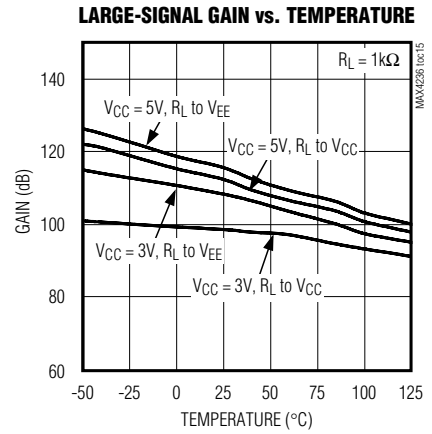
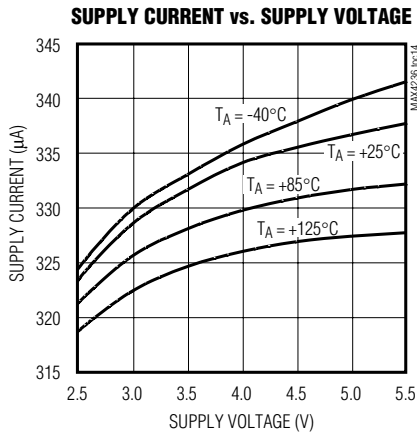
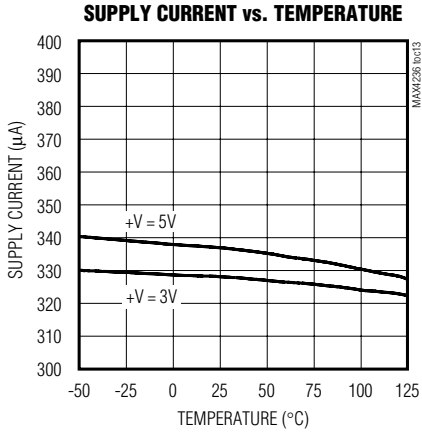

SOT23, Very High Precision, 3V/5V Rail-To-Rail Op Amps

MAX4236/MAX4237

Typical Operating Characteristics (continued)

($V_{CC} = +5V$, $V_{EE} = 0$, $V_{CM} = V_{CC}/2$, $R_L = 100k\Omega$ to $V_{CC}/2$, $T_A = +25^\circ C$, unless otherwise noted.)

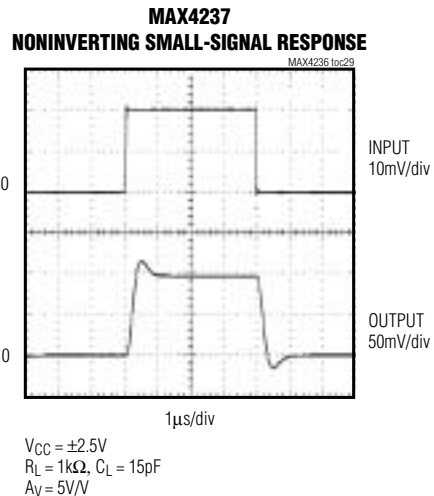
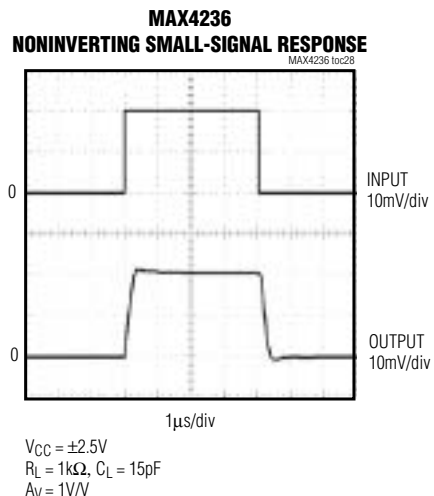
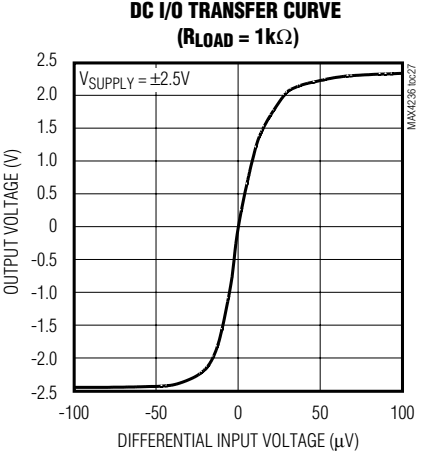
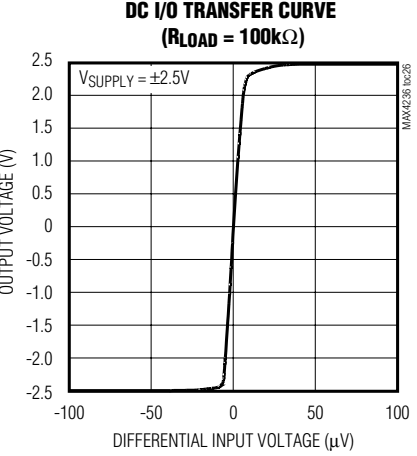
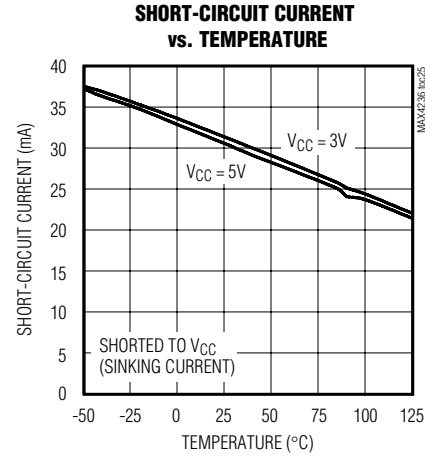
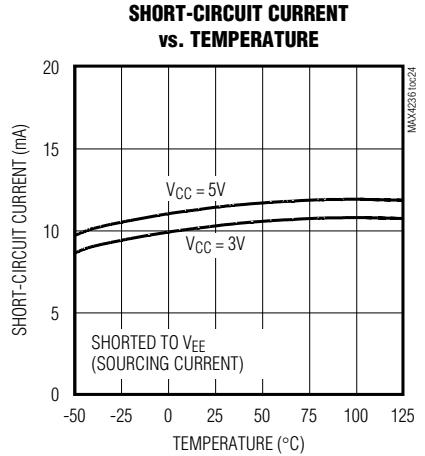
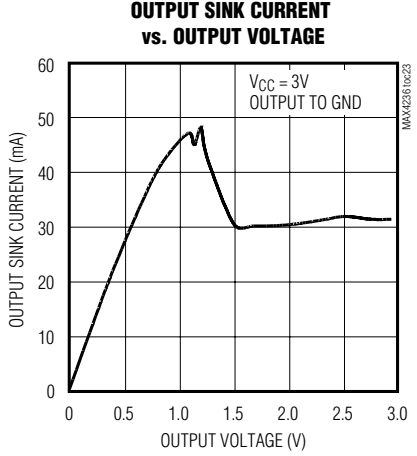
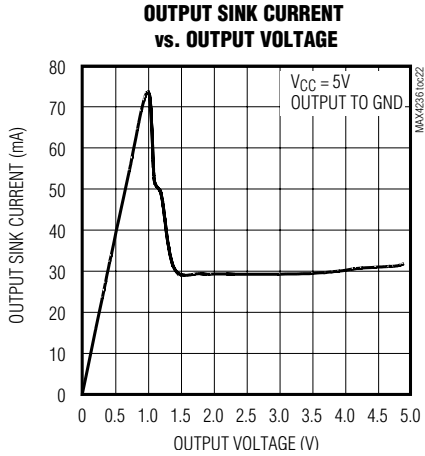

SOT23, Very High Precision, 3V/5V Rail-To-Rail Op Amps

Typical Operating Characteristics (continued)

($V_{CC} = +5V$, $V_{EE} = 0$, $V_{CM} = V_{CC}/2$, $R_L = 100k\Omega$ to $V_{CC}/2$, $T_A = +25^\circ C$, unless otherwise noted.)

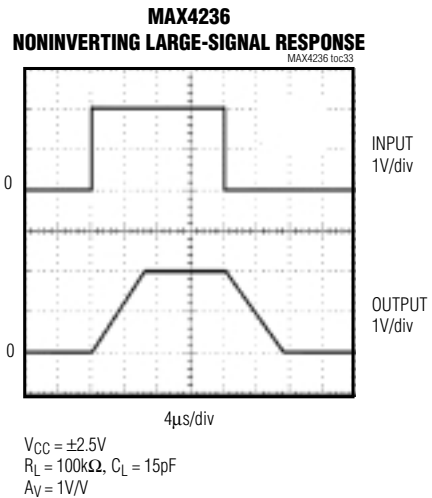
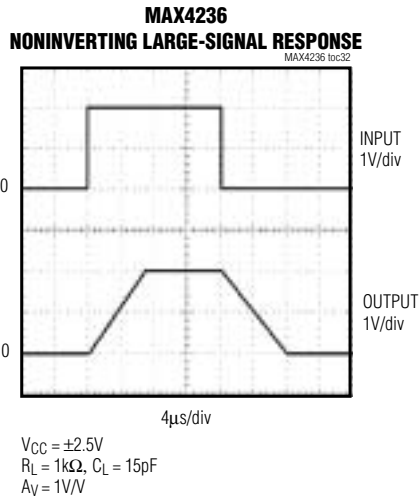
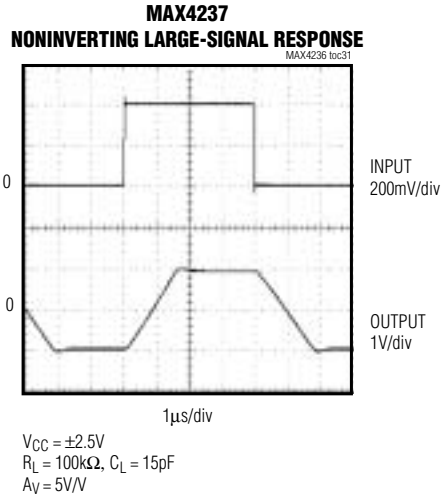
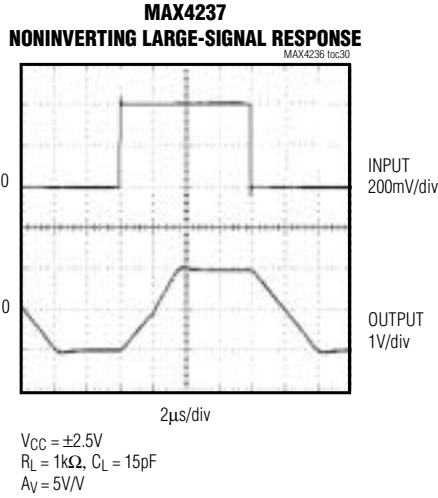

SOT23, Very High Precision, 3V/5V Rail-To-Rail Op Amps

Pin Description

PIN		NAME	FUNCTION
SOT23	SO/μMAX		
1	6	OUT	Amplifier Output
2	4	VEE	Negative Power Supply. Bypass with a 0.1μF capacitor to ground. Connect to GND for single-supply operation.
3	3	IN+	Noninverting Amplifier Input
4	2	IN-	Inverting Amplifier Input
5	8	$\overline{\text{SHDN}}$	Shutdown Input. Do not leave floating. Connect to V _{CC} for normal operation or GND to enter the shutdown mode.
6	7	V _{CC}	Positive Supply Input. Bypass with a 0.1μF capacitor to ground.
—	1, 5	N.C.	No Connection. Not internally connected.

Detailed Description

The MAX4236/MAX4237 are high-precision op amps with a CMOS input stage and an excellent set of DC and AC features. The combination of tight maximum voltage offset, low offset tempco and very low input current make them ideal for use in high-precision DC circuits. They feature low-voltage operation, low-power consumption, high-current drive with rail-to-rail output swing and high-gain bandwidth product.

High Accuracy

The MAX4236/MAX4237 maximum input offset voltage is 20μV (5μV, typ) for grade A version and 50μV for grade B version at +25°C. The maximum temperature coefficient of the offset voltage for grade A and B are guaranteed to be 2μV/°C and 4.5μV/°C respectively. The parts have an input bias current of 1pA. Noise characteristics are 14nV/√Hz, and a low frequency noise (0.1Hz to 10Hz) of 0.2μVp-p. The CMRR is 102dB, and the PSRR is 120dB. The combination is what is necessary for the design of circuits to process signals while keeping high signal-to-noise ratios, as in stages preceding high-resolution converters, or when they are produced by sensors or transducers generating very small outputs.

Rail-to-Rail Outputs, Ground-Sensing Input

The input common-mode range extends from (V_{EE} - 0.15V) to (V_{CC} - 1.2V) with excellent common-mode rejection. Beyond this range, the amplifier output is a nonlinear function of the input, but does not undergo phase reversal or latch-up (see *Typical Operating Characteristics*).

The output swings to within 150mV of the power-supply rails with a 1kΩ load. The input ground sensing and the rail-to-rail output substantially increase the dynamic range.

Power-Up and Shutdown Mode

The MAX4236/MAX4237 have a shutdown option. When the shutdown pin ($\overline{\text{SHDN}}$) is pulled low, the supply current drops to 0.1μA, and the amplifiers are disabled with the output in a high-impedance state. Pulling $\overline{\text{SHDN}}$ high enables the amplifiers. The turn-on time for the amplifiers to come out of shutdown is 4μs.

Applications Information

As described above, the characteristics of the MAX4236/MAX4237 are excellent for high-precision/accuracy circuitry, and the high impedance, low-current, low-offset, and noise specifications are very attractive for piezoelectric transducers applications. In these applications, the sensors generate an amount of electric charge proportional to the changes in the mechanical stress applied to them. These charges are transformed into a voltage proportional to the applied force by injecting them into a capacitance and then amplifying the resulting voltage. The voltage is an inverse function of the capacitance into which the charges generated by the transducer/ sensor are injected. This capacitance and the resistance that discharges it, define the low-frequency response of the circuit. It is desirable, once the preferred low-frequency response is known, to maintain the capacitance as low as possible, because the amount of necessary upstream amplification (and the signal-to-noise ratio deterioration) is directly proportional to the capacitance value. The MAX4236/MAX4237 high-impedance, low-

MAX4236/MAX4237

SOT23, Very High Precision, 3V/5V Rail-To-Rail Op Amps

current, low-noise inputs allow a minimum of capacitance to be used.

Piezoresistive transducers applications require many of the same qualities. For those applications the MAX4236/MAX4237 high CMRR, PSRR, and offset stability are also a good match.

A typical application for a piezoresistive transducer instrumentation amplifier design using the MAX4236/MAX4237 is shown in the *Typical Application Circuit*.

In general, the MAX4236/MAX4237 are good components for any application in which an amplifier with an almost zero input current is required, including high-precision, long time-constant integrators and electrochemical sensors.

Power Supplies

The MAX4236/MAX4237 can operate from a single +2.4V to +5.5V power supply, or from $\pm 1.2V$ to $\pm 2.75V$ power supplies. The power supply pin(s) must be bypassed to ground with a 0.1 μ F capacitor as close to the pin as possible.

Layout and Physical Design

A good layout improves performance by decreasing the amount of parasitic and stray capacitance, inductance and resistance at the amplifier's inputs, outputs, and power-supply connections. Since parasitics might be unavoidable, minimize trace lengths, resistor leads, and place external components as close to the pins as possible.

In high impedance, low input current applications, input lines guarding and shielding, special grounding, and other physical design and layout techniques, are mandatory if good results are expected.

The negative effects of crosstalk, EMI and other forms of interference and noise (thermal, acoustic, etc.) must be accounted for and prevented beforehand for good performance in the type of sensitive circuitry in which the MAX4236/MAX4237 are likely to be used.

Selector Guide

PART	GRADE	MINIMUM STABLE GAIN	TOP MARK
MAX4236EUT	—	1	AAUV
MAX4236AEUA	A	1	—
MAX4236BEUA	B	1	—
MAX4236AESA	A	1	—
MAX4236BESA	B	1	—
MAX4237EUT	—	5	AAUV
MAX4237AEUA	A	5	—
MAX4237BEUA	B	5	—
MAX4237AESA	A	5	—
MAX4237BESA	B	5	—

Typical Application Circuit

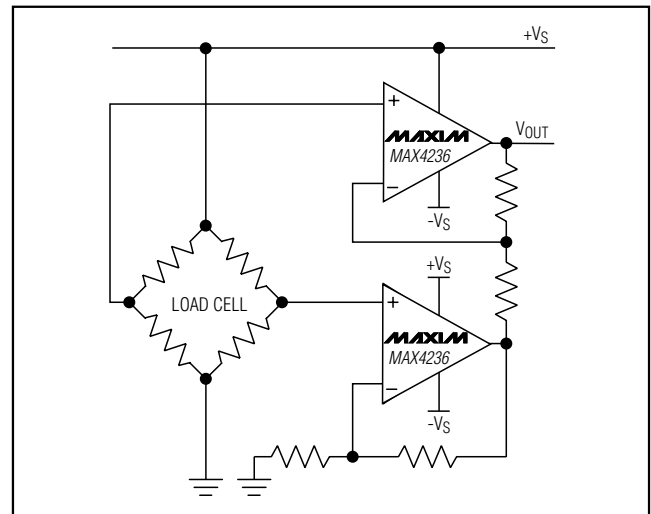

Chip Information

TRANSISTOR COUNTS: 224

PROCESS: BiCMOS

SOT23, Very High Precision, 3V/5V Rail-To-Rail Op Amps

Package Information

MAX4236/MAX4237

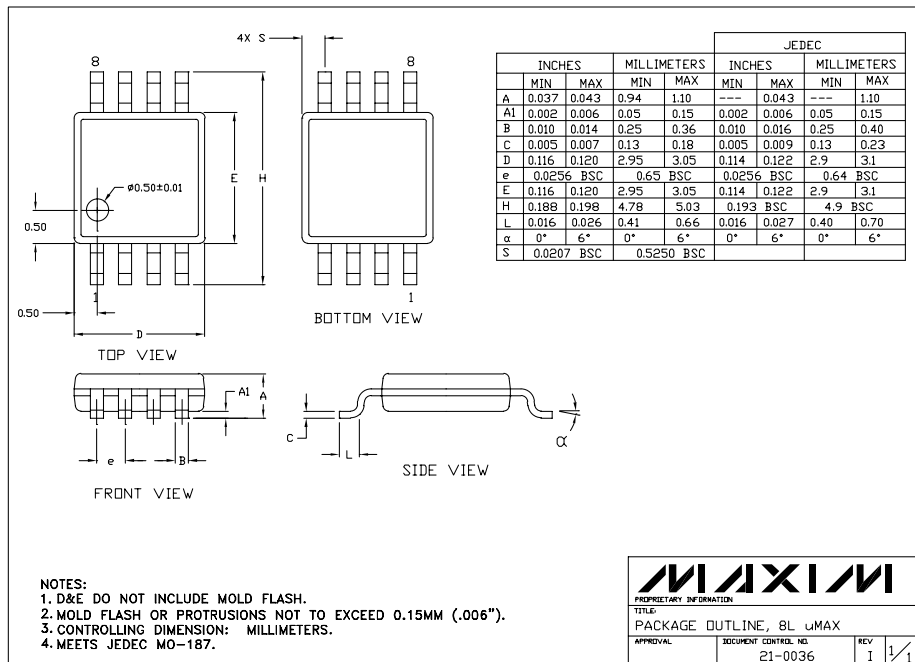
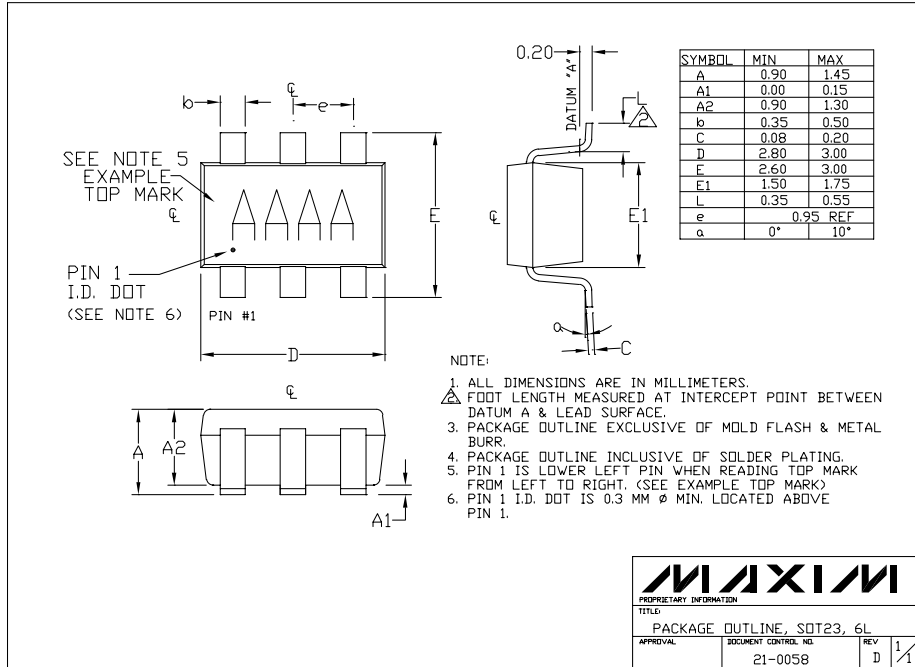

SOT23, Very High Precision, 3V/5V Rail-To-Rail Op Amps

Package Information (continued)

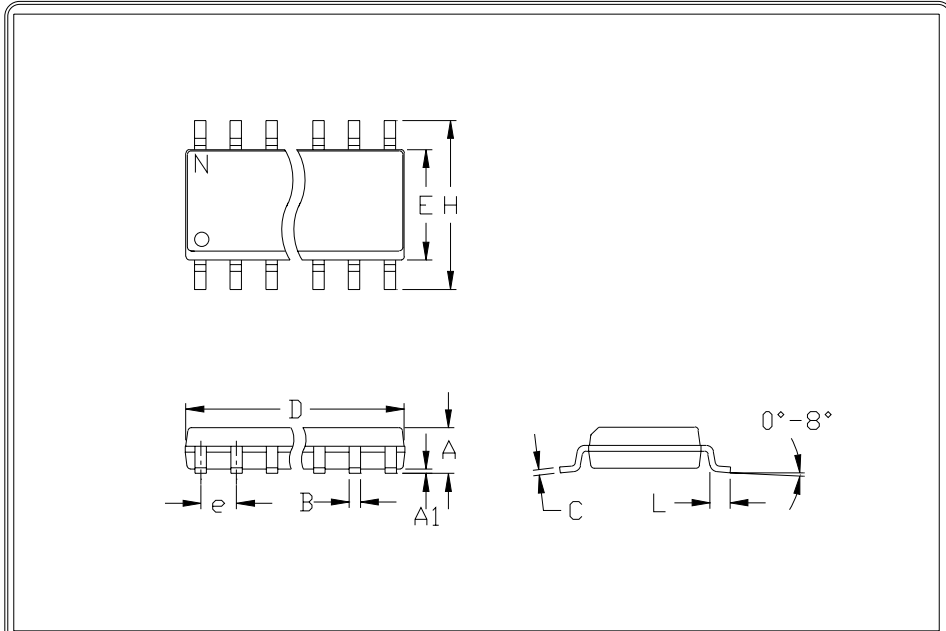

	INCHES		MILLIMETERS	
	MIN	MAX	MIN	MAX
A	0.053	0.069	1.35	1.75
A1	0.004	0.010	0.10	0.25
B	0.014	0.019	0.35	0.49
C	0.007	0.010	0.19	0.25
e	0.050		1.27	
E	0.150	0.157	3.80	4.00
H	0.228	0.244	5.80	6.20
h	0.010	0.020	0.25	0.50
L	0.016	0.050	0.40	1.27

	INCHES		MILLIMETERS		N	MS012
	MIN	MAX	MIN	MAX		
D	0.189	0.197	4.80	5.00	8	A
D	0.337	0.344	8.55	8.75	14	B
D	0.386	0.394	9.80	10.00	16	C

NOTES:

1. D&E DO NOT INCLUDE MOLD FLASH
2. MOLD FLASH OR PROTRUSIONS NOT TO EXCEED .15mm (.006")
3. LEADS TO BE COPLANAR WITHIN .102mm (.004")
4. CONTROLLING DIMENSION: MILLIMETER
5. MEETS JEDEC MS012-XX AS SHOWN IN ABOVE TABLE
6. N = NUMBER OF PINS

<p>120 SAN GABRIEL DR. SUNNYVALE, CA 94086 FAX (408) 737-7154 PROPRIETARY INFORMATION</p>	PACKAGE FAMILY OUTLINE: S01C .150"	1/1	21-0041 A DOCUMENT CONTROL NUMBER REV
---	------------------------------------	-----	--

Maxim cannot assume responsibility for use of any circuitry other than circuitry entirely embodied in a Maxim product. No circuit patent licenses are implied. Maxim reserves the right to change the circuitry and specifications without notice at any time.

14 **Maxim Integrated Products, 120 San Gabriel Drive, Sunnyvale, CA 94086 408-737-7600**